

ADAPTER KERZE (CODE 7)

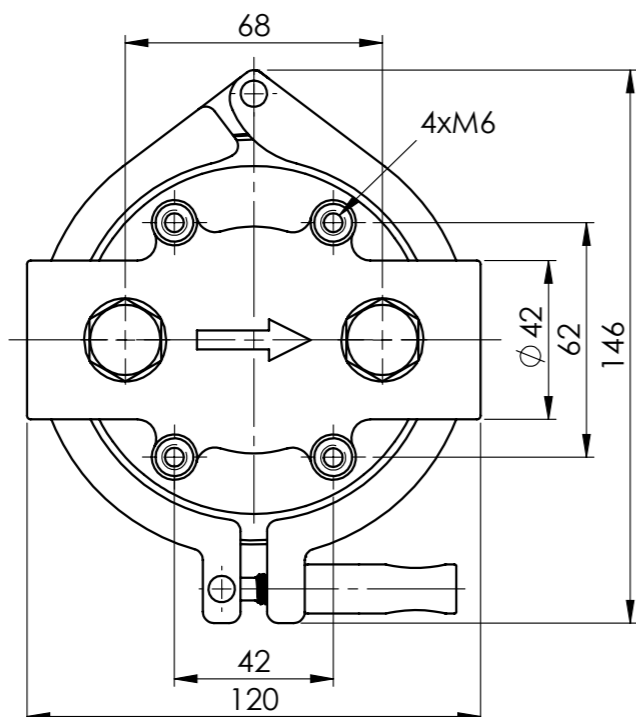
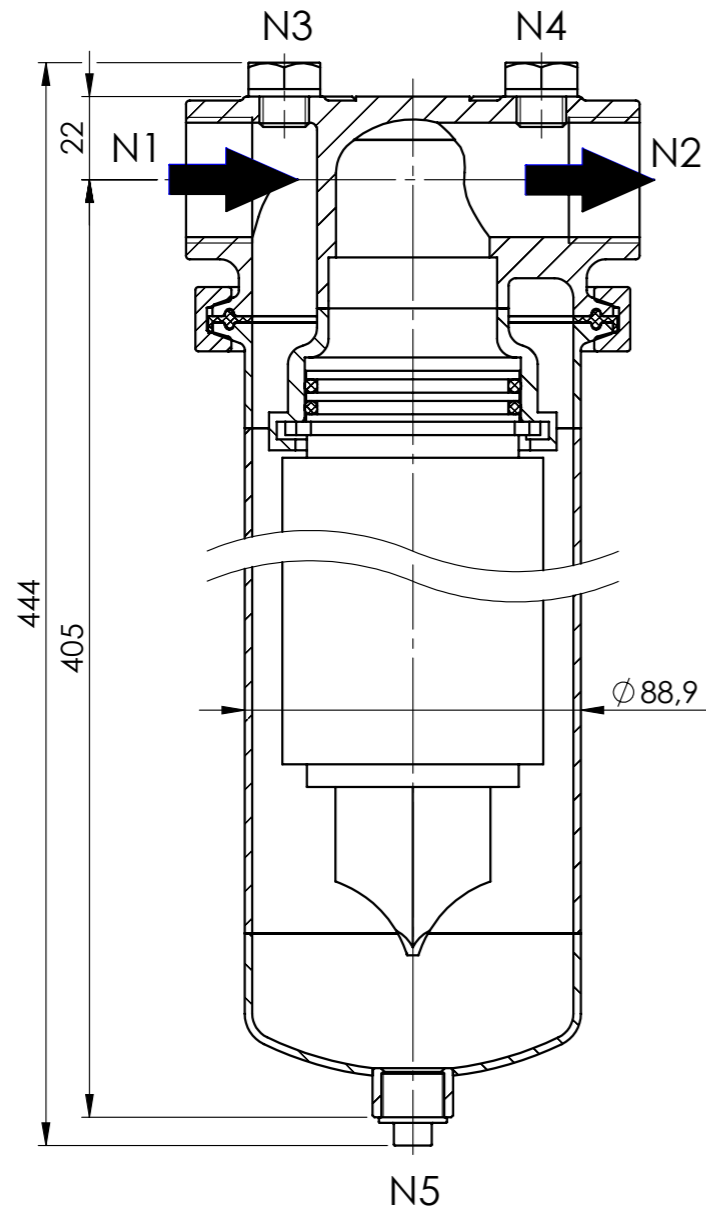

STUTZEN TABELLE

Anschluss	Größe	Typ	DIN
N1	Rp 1	Eingang	DIN 2999
N2	Rp 1	Ausgang	DIN 2999
N3	Rp 1/4	Entlüftung	DIN 2999
N4	Rp 1/4	Entlüftung	DIN 2999
N5	Rp 3/8	Entleerung	DIN 2986

SPEZIFIKATION

Max. zul. Druck	25 bar
Max. zul. Temperatur	-10/+80°C
Inhalt	2,8 l
Werkstoff Kopf	AISI 316
Werkstoff Filtersumpf	AISI 316
Werkstoff Verschlussklammer	AISI 304
Werkstoff Dichtung	FPM
Adapter Kerzen	10" - CODE 7
Gewicht	4,3 kg



Abb. abweichend

	Datum	Name	Typ	1FUCB1-25/25-A4F
	12.08.2014	Leekes		
Bearb.				
Gepr.				
Norm			Artikel-Nr.	1754812025
 Am Weinkastell 14 55270 Klein-Winternheim			Zugehörige Zeichnung: 10-1403 Rev.0	Erst.f.: